

for Models **SI-101 & SI-201**

Programs
in Ladder
Logic



PLC on a Chip Patent 7,299,099

SOLVES-IT!

User's Manual

REV .2

A larger format of this manual may be
found at <http://www.divelbiss.com>



Smart Parts for Managing Automation

9778 Mt. Gilead Rd.
Fredericktown, OH 43019
Toll Free: 1-800-245-2327
Web: <http://www.divelbiss.com>
Email: sales@divelbiss.com

2008017.2

IMPORTANT INFORMATION

REGARDING SOLVES-IT CONTROLLER SHIPMENTS

To provide greater flexibility and reliability, *Solves-It* shipments are factory programmed without a KERNEL. You must install the kernel prior to being able to download EZ LADDER programs.



**THE SOLVES-IT WILL NOT FUNCTION UNLESS
THIS STEP (KERNEL LOADING) IS COMPLETED.**

To install the Solves-It's kernel:

1. Connect the serial cable from the PC to the SI-101 / SI-201 (Programming Port).
2. Open the EZ LADDER Toolkit.
3. To load the kernel, you must configure the target and have at the minimum a one-rung program. For your convenience a program is pre-loaded on your computer (for EZ LADDER versions 1.0.4.4 and later). The file is named **GetStarted_SI-100_SI-101_SI-200_SI-201.dld** and can be found in the Kernel Install Start Programs sub-directory where you installed EZ LADDER.

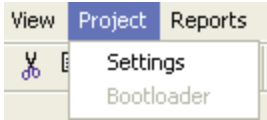
OR

Otherwise, create your own using the **Projects....Settings** Menu,  select the "Solves-IT" target and click the PROPERTIES button. Using the drop down menu, select the SI-100 if using the SI-101 or SI-200 if using the SI-201 and click OK. You may also load a pre-saved ladder diagram that uses the same target. Verify the COM port is set correctly and click OK to exit the *Project Settings*. See the EZ LADDER User's Manual for details on configuring targets.

4. Click the  (Monitor) button to change from the 'Edit' to 'Monitor' Mode.
5. Click the  (Connect) button to connect to the target. A dialog will appear automatically when no kernel is loaded.
6. Click the **BROWSE** button and select the target's kernel (**by partnumber**) located by default at `C:\Program Files\EZ Ladder\Kernel\`

The following are kernel names and descriptions:

File Name

Solves-IT.dat
Solves_IT_SI_100.dat

Description

Kernel for Solves-It
Kernel for Solves-it

To be Used on (Partnumber)

SI-101, SI-201 (EZ LADDER V1.0.3.0 or earlier)
SI-101, SI-201 (EZ LADDER V1.0.4.0 or later)

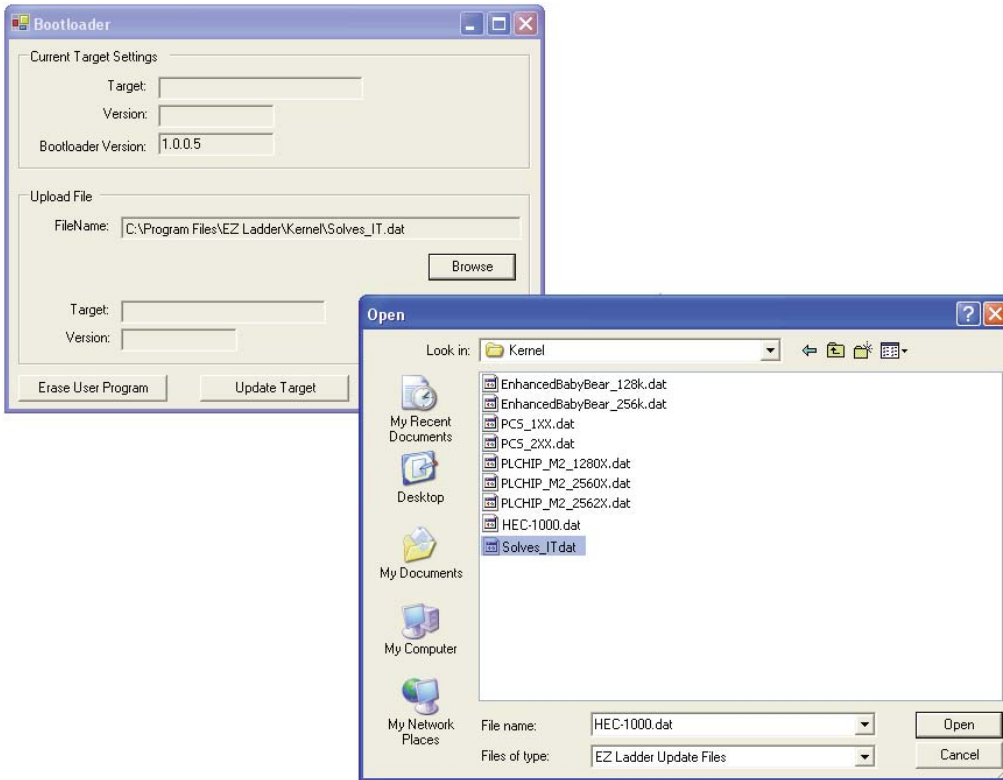

7. Click the **OPEN** button to finish the kernel selection. Make sure the correct kernel is chosen.
8. Click the **UPDATE TARGET** button to install the kernel.

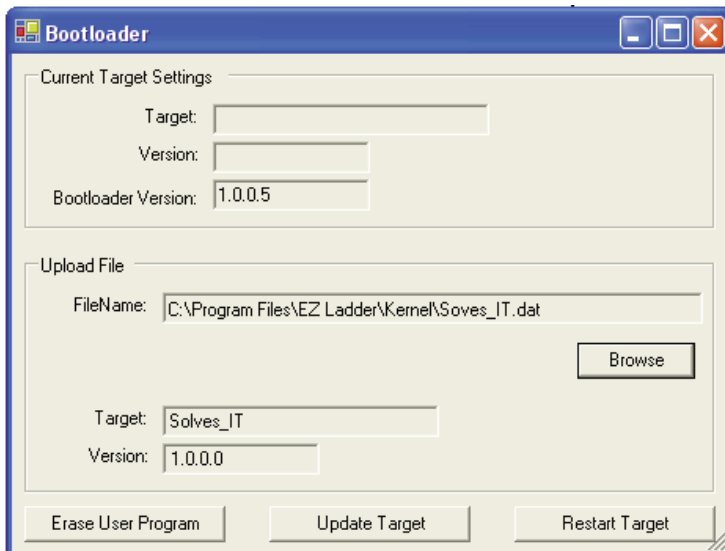

9. A dialog box will appear to show the status of the kernel installation. This could take a couple of minutes to install.
10. When the dialog windows close, the installation is complete. The Solves-It may be connected to normally and programs may be downloaded.

TABLE OF CONTENTS

Table of Contents	Page 1
Package Contents	Page 1
Getting Started	Page 2
How to Use this Manual	Page 3
Configuring the Solves-It! Target in EZ LADDER	Page 4
Solves-It! Common Features	Page 5
Getting to Know the Solves-It!	Page 6
Solves-It! Mounting	Page 7
Solves-It! Input Power	Page 7
Status LED	Page 8
Programming Port	Page 8
Digital Inputs	Page 9
Counter Inputs	Page 10
Digital Outputs	Page 11
Programmable LED Indicators	Page 11
Retentive Memory	Page 11
EEPROM Memory	Page 12
Specifications	Page 13
SI-201 Exclusive Features	Page 14
Real Time Clock	Page 15
Programmable Push Buttons	Page 15
Programmable Display	Page 15

WARNING!

The SI-101 or SI-201, as with programmable controllers, must not be used alone in applications which would be hazardous to personnel in the event of failure of this device. Precautions must be taken by the user to provide mechanical and/or electrical safeguards external to this device. This device is **NOT APPROVED** for domestic or human medical use.

PACKAGE CONTENTS

Whats Included

Qty	Description	Part Number	Location
1	Controller	SI-101 or SI-201	In Box
1	Solves-It! 101/201 Manual	2007017.X	In Box
4	Commutating Diodes	111-101012	In Box

GETTING STARTED

This section explains how to read this manual and understand the symbols.

HOW TO USE THIS MANUAL

In this manual, the following conventions are used to distinguish elements of text:

BOLD	Denotes labeling, commands, and literal portions of syntax that must appear exactly as shown.
<i>italic</i>	Used for variables and placeholders that represent the type of text to be entered by the user.
SMALL CAPS	Used to show key sequences or actual buttons, such as OK, where the user clicks the OK button.

In addition, the following symbols appear periodically in the left margin to call the readers attention to specific details in the text:



Warns the reader of a potential danger or hazard that is associated with certain actions.



Appears when the text contains a tip that is especially helpful.



Indicates that the text contains information to which the reader should pay particularly close attention.

All Specifications Subject to Change without Notice

CONFIGURING THE SOLVES-IT! TARGET IN EZ LADDER

Before you can program and use the Solves-It! Controller, it must be configured as a target within EZ LADDER. For help with installing or using EZ LADDER, please refer to the EZ LADDER User's Manual.

In EZ LADDER, select **PROJECT....SETTINGS**. This will open the *Project Settings Window*. Select "Solves-It" for the target. Click on **PROPERTIES**. The Solves-It dialog box will open. Using the drop down menu, select the SI-100 if using the SI-101 or SI-200 if using the SI-201 and click **OK**. Click **OK** again to close the *Project Settings Window*. Figure 1.1 show the *Project Settings Window and Solves-It Properties* dialog box.

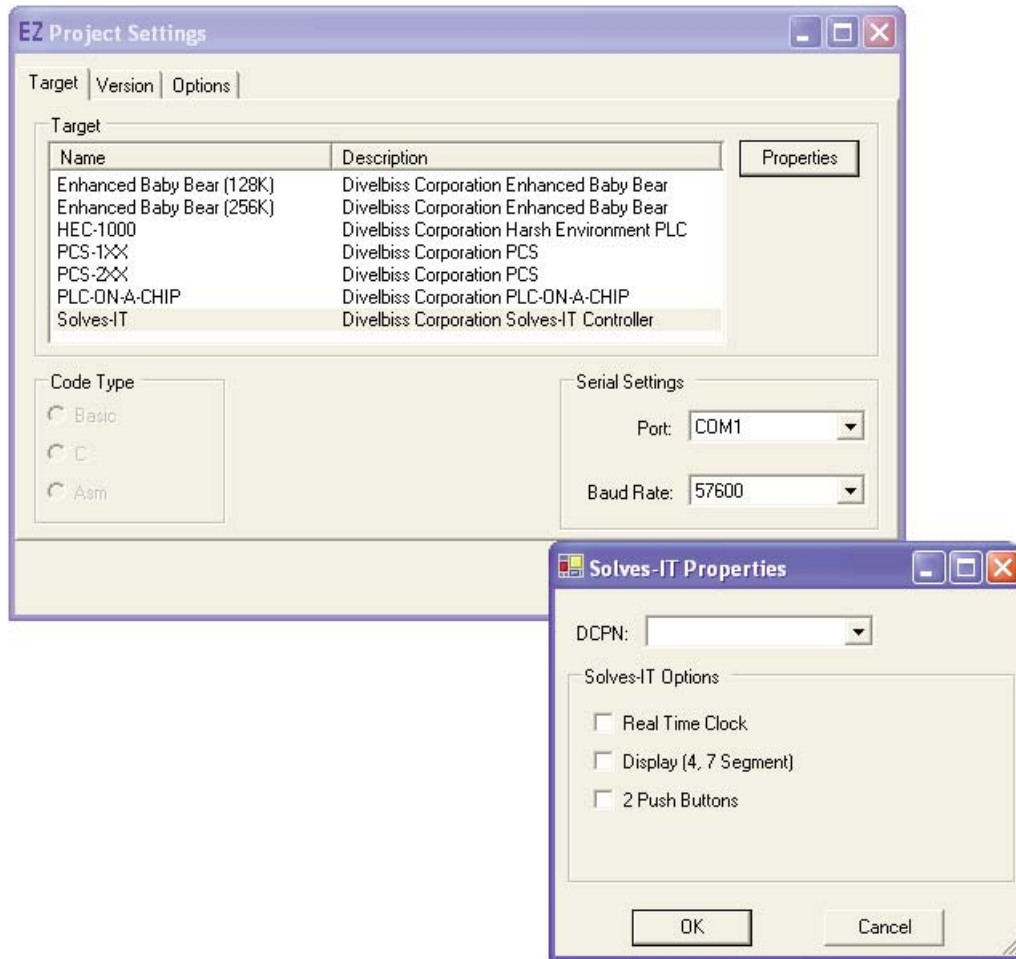

Figure 1.1

Once you have configured the Solves-It! target, EZ LADDER automatically creates variables for the Inputs, Outputs, Programmable LEDs and Programmable Push Buttons (SI-200 only). For each variable, the appropriate I/O address is automatically programmed for quick reference to use in the ladder program.

The following are created automatically:

Variable Name	I/O Address	Description	Variable Name	I/O Address	Description
GPI0	GPI0	Digital Input 0 (GPI0)	GPO3	GPO3	Digital Output 3 (GPO3)
GPI1	GPI1	Digital Input 1 (GPI1)	LED1	LED1	Programmable LED # 1 (I1)
GPI2	GPI2	Digital Input 2 (GPI2)	LED2	LED2	Programmable LED # 2 (I2)
GPI3	GPI3	Digital Input 3 (GPI3)	LED3	LED3	Programmable LED # 3 (I3)
GPO0	GPO0	Digital Output 0 (GPO0)	LED4	LED4	Programmable LED # 4 (I4)
GPO1	GPO1	Digital Output 1(GPO1)	PB1	PB1	Programmable Pushbutton # 1
GPO2	GPO2	Digital Output 2(GPO2)	PB2	PB2	Programmable Pushbutton # 2

SOLVES-IT! COMMON FEATURES

This section describes the hardware features and options including using EZ LADDER to operate the hardware that are common for all Solves-It! models.

GETTING TO KNOW THE SOLVES-IT!

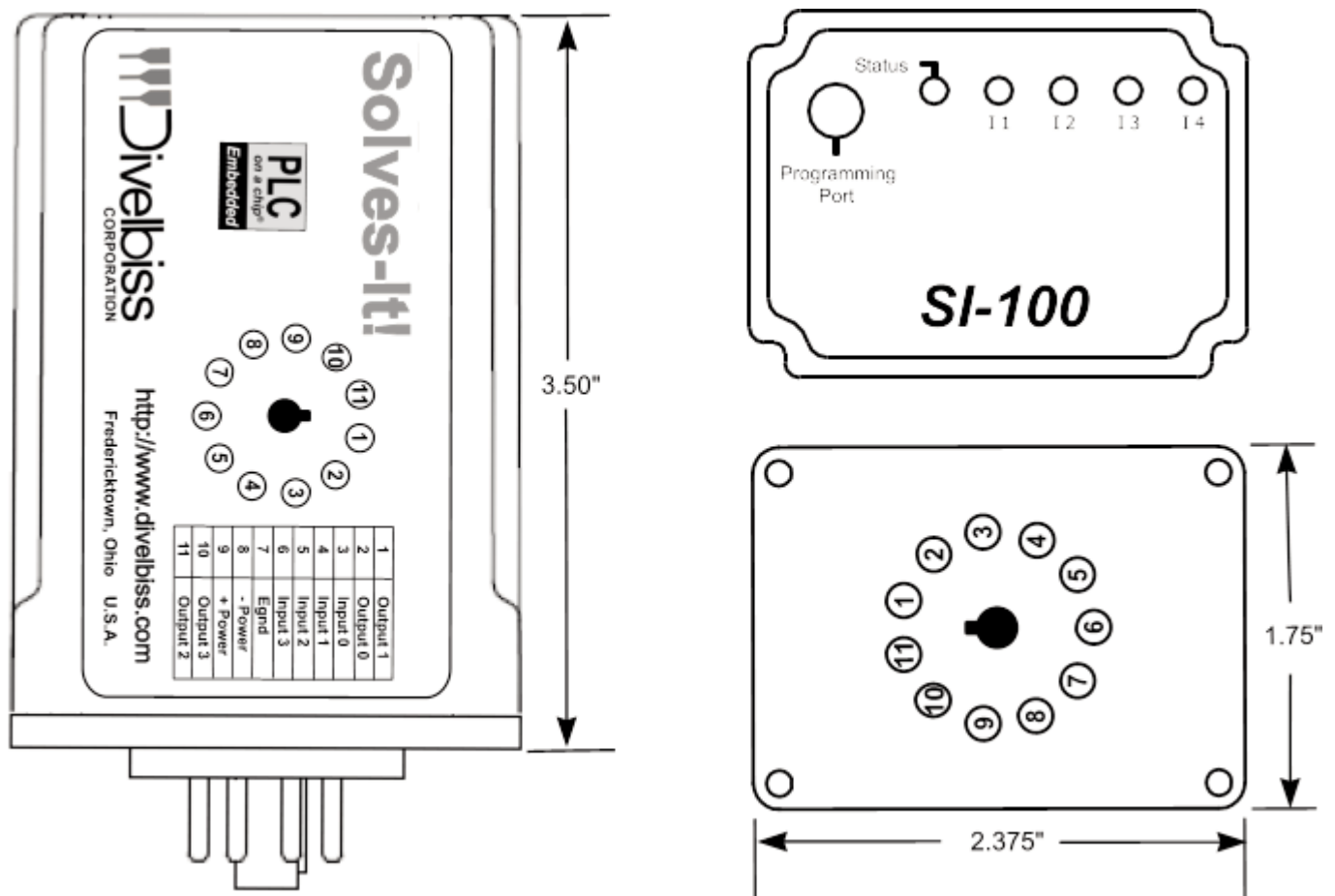

The Solves-It! is connected to external devices via its mounting socket, Divelbiss part number 115-105328 (not supplied), once it has been mounted. The Solves-It! is programmed via its programming port using the programming cable SI-PGM.

Connector Pin out

Bottom View (Solves-It! Connector)

Pin 1	Output 1
Pin 2	Output 0
Pin 3	Input 0
Pin 4	Input 1
Pin 5	Input 2
Pin 6	Input 3
Pin 7	EGnd
Pin 8	- Power (Common)
Pin 9	+VDC Input Power
Pin 10	Output 3
Pin 11	Output 2

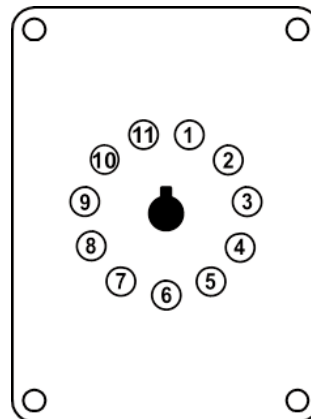

Figure 2.1 - Solves-It! Connections

SOLVES-IT! MOUNTING

The Solves-It! Controller mounts to industry standard 11-pin Octal relay socket. To mount the Solves-It!, align with the socket and firmly push into position.

SOLVES-IT! INPUT POWER

The Solves-It! may be powered using 10-24VDC. The input power must be of sufficient supply to drive the Solves-It! controller and all the digital outputs (based on the load currents for each) Maximum current for the Solves-It! is 150mADC and maximum load for each outputs is 300mADC making the total power supply requirement 1.35ADC(if all outputs will be used to maximum capacity). See Figure 2.2. Chassis ground is recommended for noise immunity.

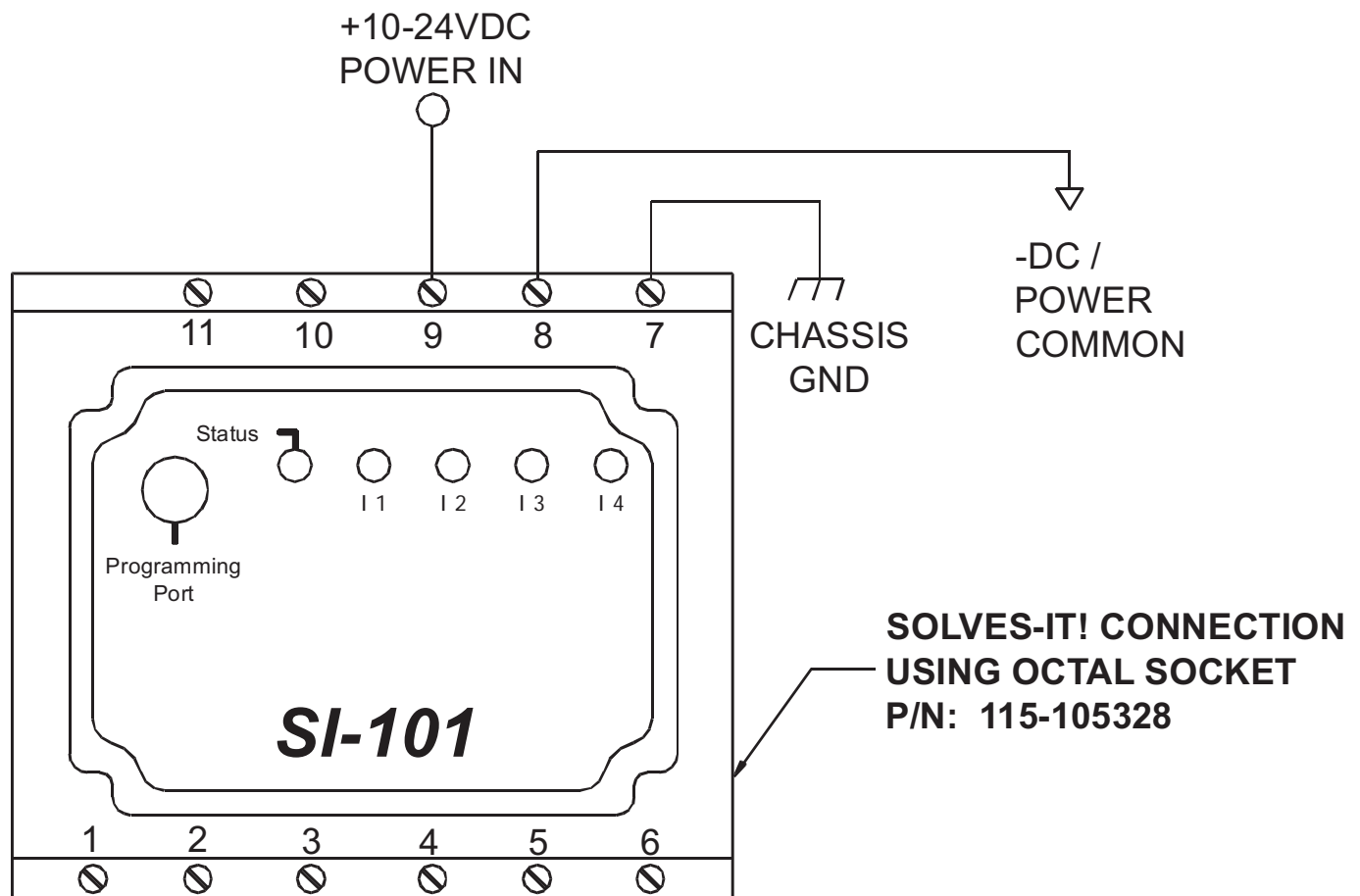

Figure 2.2 - Solves-It! Input Power

STATUS LED



The operating status of the Solves-It! can be determined by the Status LED. When the Status LED is flashing at a slow rate, approximately once per second, then there is no program executing. When the Status LED is flashing at a fast rate, approximately 10 times per second, a program has been loaded and it is executing.

Should the Status LED not flash at all, first check the input power. If the input power is correct and there is still no Status LED, contact Divelbiss Technical Services.

PROGRAMMING PORT

The Solves-It! is programmed using its Programming Port. This RS232 serial port is only to be used for programming using Divelbiss' EZ LADDER. The Programming Port defaults to 57600,N,8,1. This is not a general purpose port. See Figure 2.3.

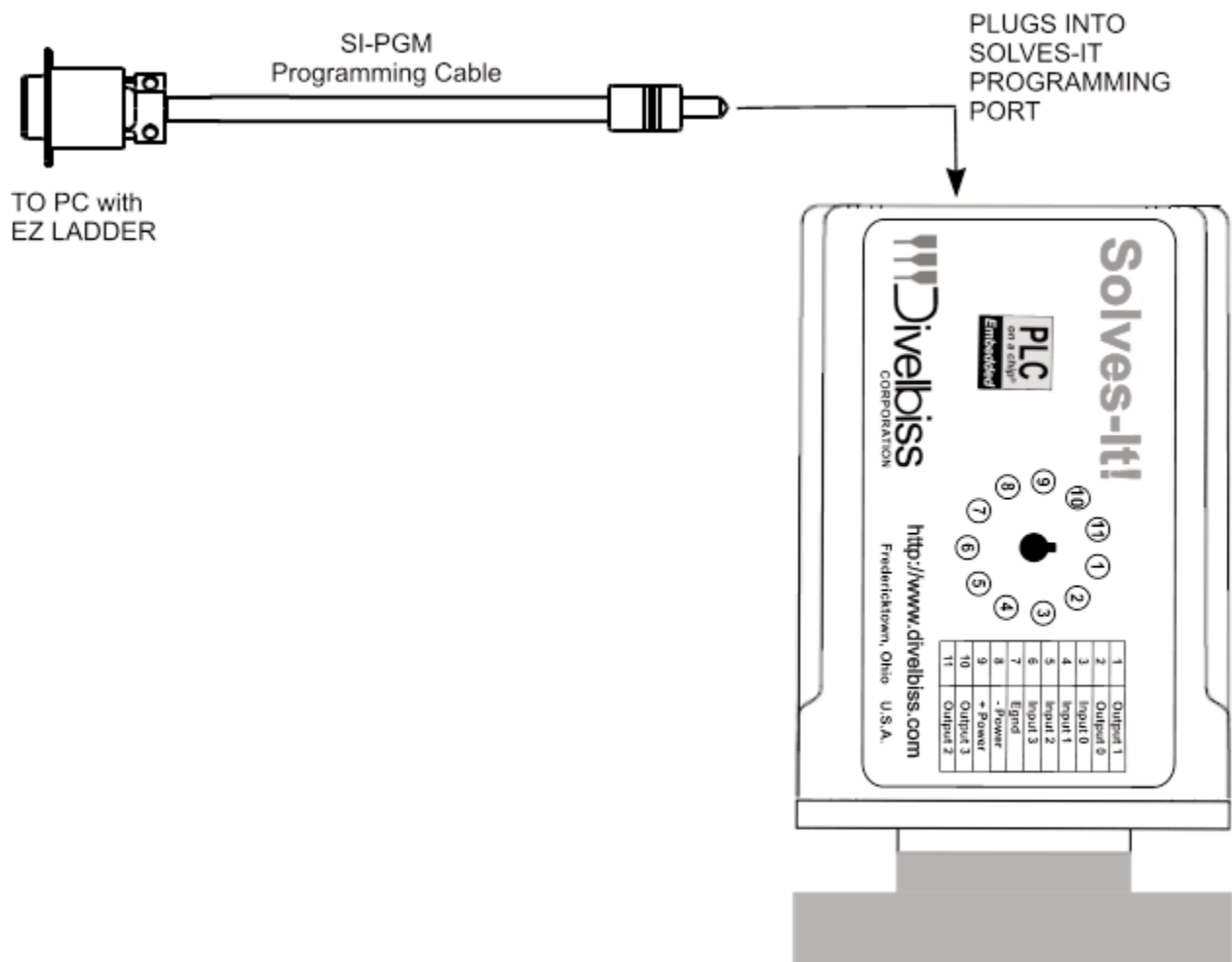

Figure 2.3 - Programming Port

DIGITAL INPUTS

The Solves-It! includes 4 on-board digital inputs. They are identified as GPIO - GPI3 and will sink an input voltage of 10-24VDC. All digital inputs are optically isolated to promote noise immunity.

GPI1 may be used as a general purpose input or high speed counter; while GPIO, GPI2 & GPI3 can only be used as general purpose inputs. For information on using GPI1 as a high speed counter input, refer the COUNTER INPUTS Section, page 10 of this manual .

To access the digital inputs in the ladder diagram, use the DIRECT CONTACT and INVERTED CONTACT objects.

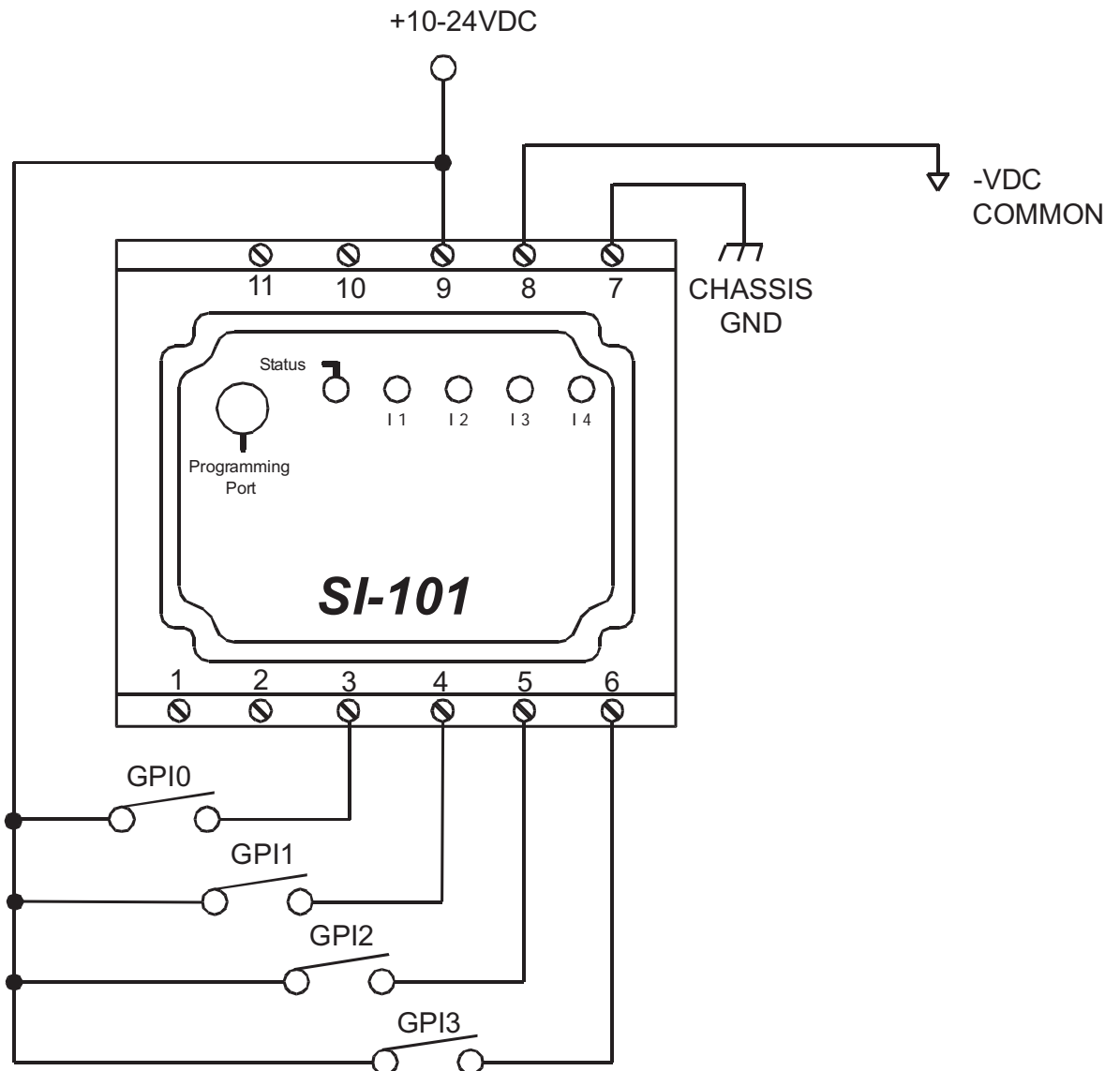

Figure 2.4 - Typical Digital Input Connections

COUNTER INPUTS

One of the digital inputs (GPI1) may be utilized as a high speed counter (up count). The GPI1 input will operate as a counter up to the maximum input rate of 25KHz. The counter input is optically isolated to promote noise immunity. The High speed counter input uses the EZ LADDER function: CNTRTMR.

Typical High Speed Counter connections are shown in Figure 2.5.

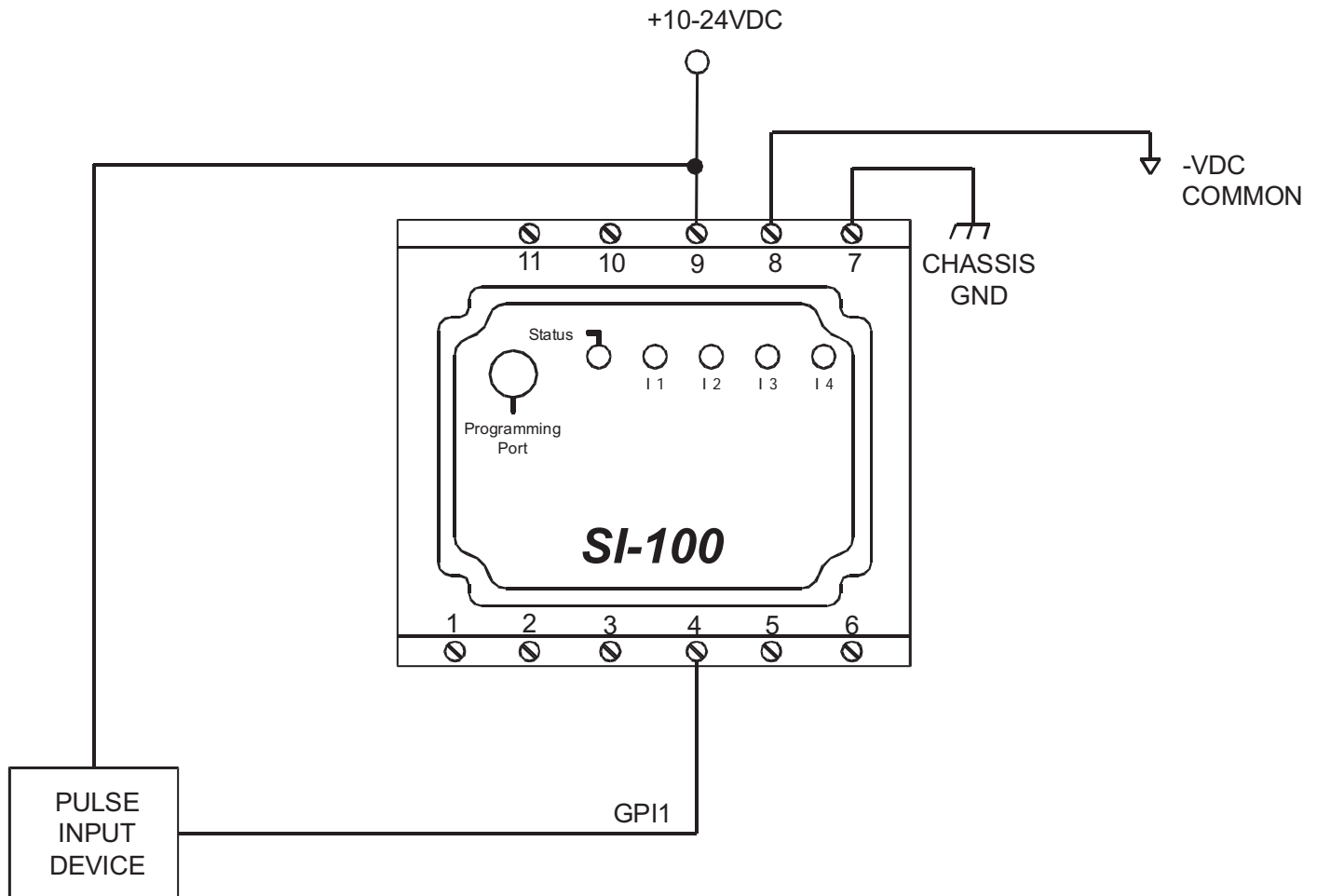

Figure 2.5 - Typical Counter Input Connections

DIGITAL OUTPUTS

The Solves-It includes 4 sinking on-board digital outputs. They are identified as GPO0 - GPO3. These outputs can sink up to 24VDC and drive a load up to 300mA maximum (resistive). Depending upon the device connected to an output, a minimum load resistor may be required. If the output is "ON" at all times, connect a 470Ω to 1KΩ load from the output to +V.

To access the digital outputs in the ladder diagram, use the DIRECT COIL and INVERTED COIL objects.

When connecting DC inductive loads such as valves or coils, use the supplied commutating diodes as shown in Figure 2.6 to improve noise immunity and protect the outputs. When switching AC loads using relays, install MOVs or other suppression devices (not supplied).

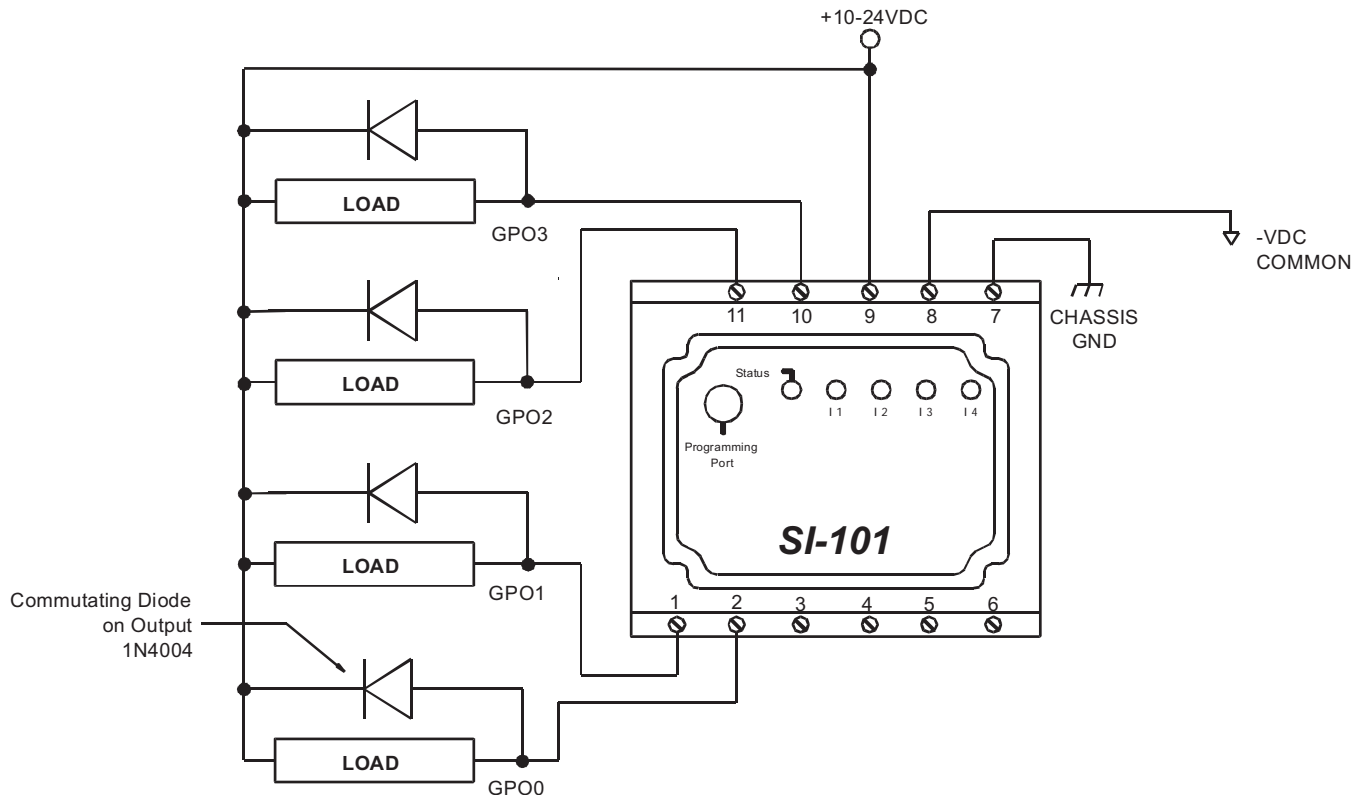

Figure 2.6 - Typical Digital Output Connections

PROGRAMMABLE LED INDICATORS

The Solves-It includes 4 on-board programmable LED indicators (labeled on the case as I1-I4). These indicators may be used to identify or indicate any condition in the ladder logic program. These LED indicator I/O addresses are LED1-LED4

To access the LED Indicators in the ladder diagram, use the DIRECT COIL and INVERTED COIL objects. These indicators are automatically have variables labeled LED1 - LED 4.

RETENTIVE MEMORY

The Solves-It model SI-201 does support the use of retentive memory variables. Each variable must be 'declared' as retentive for proper operation.

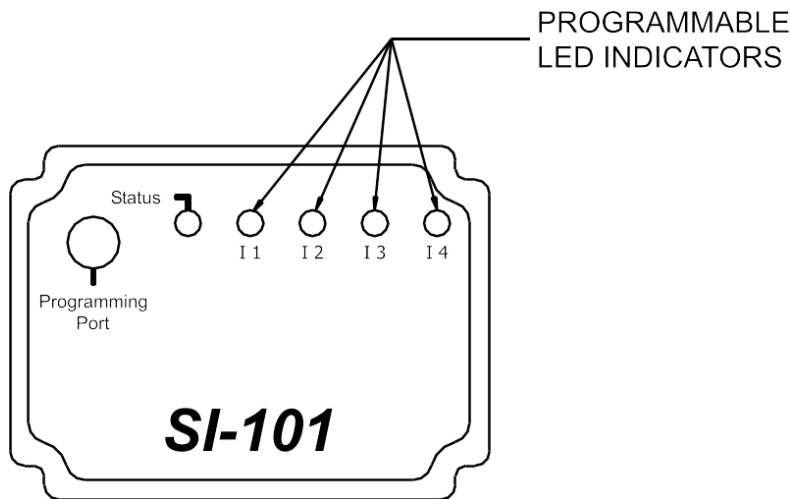

Figure 2.7 - LED Indicators

EEPROM MEMORY

As one of the standard features of PLC on a Chip™ and EZ LADDER Toolkit, the SI-101/SI-201 supports the use EEPROM memory that may be used to store and recall boolean, integer, real and timer values in non-volatile memory in the ladder diagram. This can be used to store field adjustable set points and more.

The SI-101/SI-201 supports 128 bytes of EEPROM memory. This memory is accessed in the ladder diagram using the EEPROM_READ and EEPROM_WRITE Function blocks. The same variable type that writes to the EEPROM location should be used to read the EEPROM location. A memory map is recommended for organizing variables stored in EEPROM.

Each EEPROM address is absolute and is one byte in size. Boolean variables fill two bytes while all other variable types fill four bytes of EEPROM. When writing a boolean to address 0, the actual variable will use addresses 0 and 1 (two bytes). Should you write an integer variable into address 0, then it would use addresses 0-3. A memory map should be created and used to assign variable types and addresses prior to coding to ensure that variable size and types are accounted for.

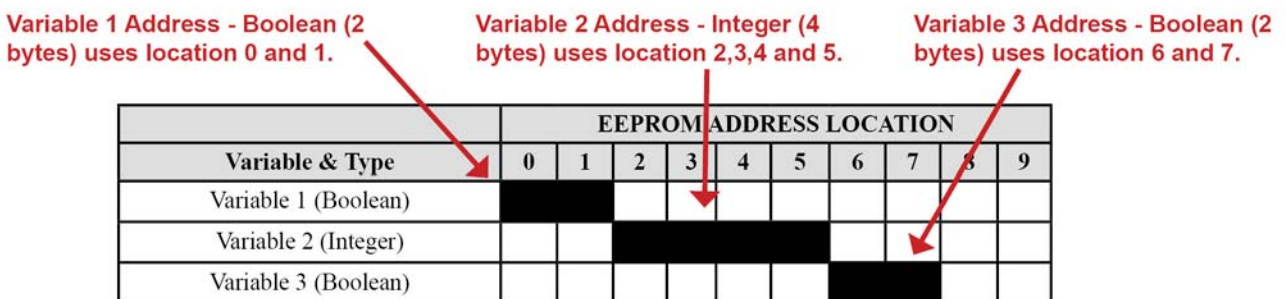

Figure 2.8 - EEPROM Memory

EEPROM storage area has a limited number of write cycles; therefore it shouldn't be used to store data which changes often and must be re-written often. Writing often to the same location can cause the location to fail.

SPECIFICATIONS

Processor:	PLC on a Chip™
Memory:	64K Flash, 128 Bytes EEPROM
Serial Ports:	1 Programming Port (Max baud: 57.6K);
Digital I/O:	4 Sinking Inputs, rated 10-24VDC. 4 Sinking SSR Outputs, rated 10-24VDC @ 300mADC Max.
Real Time Clock*:	Time of Day, Day, Month, Year & Day of Week
Counters:	1 Channel, Count Up. GPI1 = 25KHz Max.
Power Requirements:	10-24VDC @ 150mADC Max
Indicators:	4 Programmable LED Indicators, 1 Status LED Indicator
Display*:	4 Digit, 7 Segment Programmable LED Display
Push Buttons*:	2 Programmable Push Buttons
Operating Temp:	0-60° C
Program Language:	Ladder Logic using Divelbiss EZ LADDER or EZ LADDER LITE.
Dimensions:	2.4" Wide x 1.75" Length x 4.2" Tall.
Mounting:	Plugs into Industry standard 11-pin Octal Relay Socket
Type:	Plastic Housing

* Indicates features only available on model SI-201.

SI-200 EXCLUSIVE FEATURES

This section describes the hardware features and options including using EZ LADDER to operate the hardware that is specific to the Solves-It! Model 201 (SI-201).

REAL TIME CLOCK

The SI-20` includes a Real Time Clock. The real time clock (after being set) provides the Month, Day, Day of the Week, Year, Hour, Minute and Second. The real time clock maintains time when power is lost via lithium battery. The Real Time Clock may be accessed using the EZ LADDER functions: GETDATE, GETTIME, SETTIME, SETDATE.

PROGRAMMABLE PUSH BUTTONS

The SI-201 includes two programmable push buttons (labeled on the case as B1 and B2). These push buttons are I/O addressed using PB1 and PB2 in EZ LADDER.

To access the push buttons in the ladder diagram, use the DIRECT CONTACT and INVERTED CONTACT objects. These push buttons are automatically have variables labeled PB1, PB2. See Figure 3.1.

PROGRAMMABLE DISPLAY

The SI-201 includes a programmable 4 digit, seven-segment display. This display may be used to display setpoints, actual timers and more. See Figure 3.1.

To access the display in EZ LADDER, use the SI_DISP and SI_CLRDISP

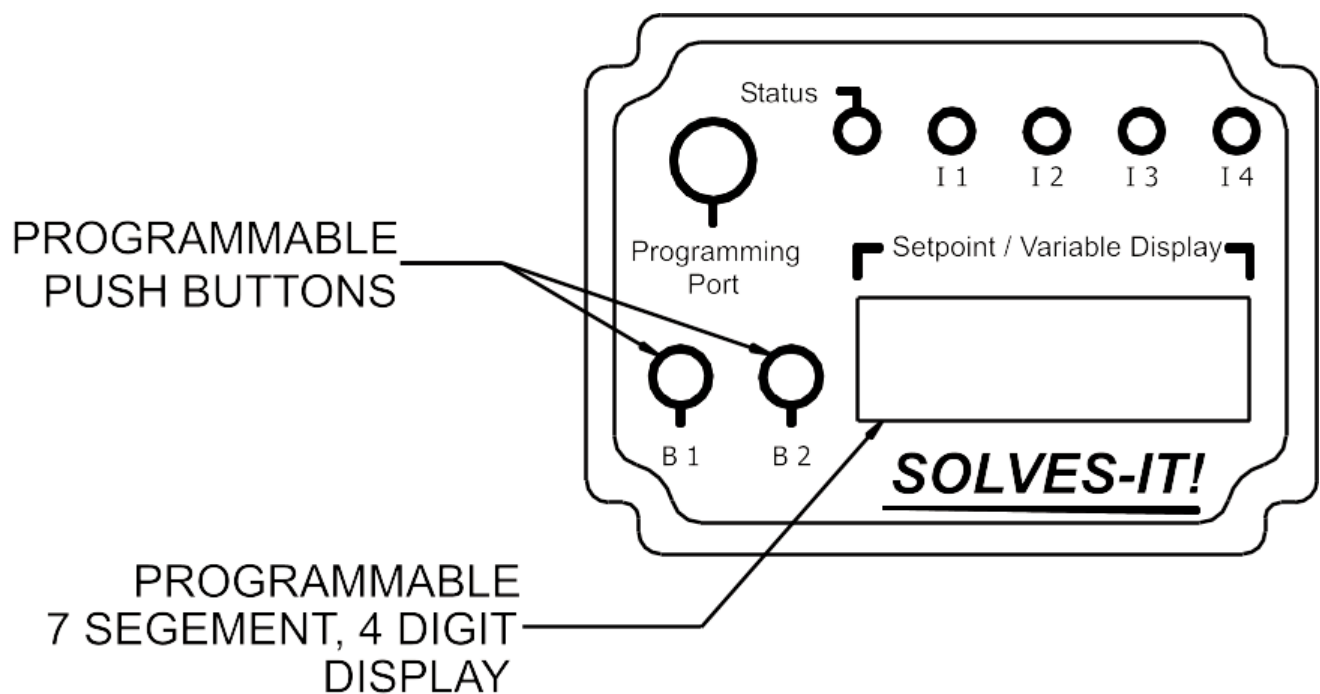

Figure 3.1 - Push Buttons and Display

Limited Warranty

Divelbiss Corporation warrants equipment will be free from defects in material and workmanship for a period of one (1) year from the date of the Divelbiss invoice that the equipment was furnished. Divelbiss Corporation will not be liable for any design furnished by Buyer and incorporated into the equipment.

In no event shall Divelbiss Corporation be liable for anticipated profits, consequential damages or loss of use of equipment or of any installation into which the equipment covered by this order may be put.

Divelbiss Corporation shall not be liable or responsible for any loss, injury, or damage resulting directly or indirectly from the use of software and/or programming in any way associated with the equipment of this order.

Obligations are to be limited to the repair or replacement at the Divelbiss Corporation plant, Fredericktown, Ohio, upon return of the part or component in question, prepaid by Buyer. The return freight charges to be paid by Divelbiss. The part or component is only to be returned to Divelbiss with a Returned Material Authorization number issued by the Divelbiss Service Department. Any warranty service (consisting of time, travel, and expenses related to such services) performed other than at Divelbiss Corporation plant, shall be at Buyer's expense.

Warranty of repaired or replacement products will be limited to ninety (90) days or the remainder of the original warranty whichever is greater.

Warranty is available only if Divelbiss Corporation is promptly notified in writing upon discovery of any alleged defect and examination of the subject product discloses, to Divelbiss satisfaction, that any defect has not been caused by misuse; neglect; improper installation; improper operation; improper maintenance, repair, or alteration; accidents; or unusual deterioration or degradation of the equipment or parts thereof due to physical environment or due to electrical or electromagnetic noise environment.

This warranty is in lieu of all other warranties, expressed, implied, or statutory, including warranties of merchantability or fitness for a specific purpose.