

PLCTM *on a chip* Technology

DEVELOPMENT PACKAGE DATA SHEET



PLC on a Chip Patent 7,299,099



Divelbiss Corporation
9778 Mt. Gilead Rd.
Fredericktown, Ohio 43019

1-800-245-2327
<http://www.divelbiss.com>
<http://www.plconachip.com>

Table of Contents

Getting Started

What's Included in the Development Package	Page 4
Enabling the Battery	Page 4
Other Support Information	Page 4
Main Board Diagram	Page 5

Main Board Features

Input Power	Page 7
Serial Ports	Pages 7-8
Analog Inputs	Page 8
CAN Ports	Pages 8-9
I/O Assignments	Page 9
Installing / Removing I/O Modules	Page 10
Installing / Removing the PLC on a Chip Module	Page 10
Connecting I/O	Pages 11-12
Counter Inputs	Page 12
High Density I/O Interface	Page 13
Real Time Clock	Page 13
Additional Expansion Ports - Connector P47	Page 13

Getting Started

What's Included in the Development Package

The PLC on a Chip Development Package provides all the basic components needed to begin to use a PLC on a Chip product in your design. This package includes the necessary hardware and software. Included on the CDs is the EZ LADDER Development Software and a complete library of documents including circuit design guidelines and PCB layout guidelines.

What's in the Box:

Qty	Description	Part Number	Located Where
1	PLC on a Chip Module	PLCMOD-M2-25631	Installed on PLCDKMB
1	Development Kit Main Board	PLCDKMB	Loose Packed In Box
4	110VAC Input Module	BM-0470048-2AC	Installed on PLCDKMB
4	12-24VDC Input Module	BM-0470048-2DC	Installed on PLCDKMB
4	12-24VDC Output Module	BM-0470048-3	Installed on PLCDKMB
4	110VAC Output Module	BM-0470048-4	Installed on PLCDKMB
2	Relay Output Module	BM-0470048-5	Loose Packed In Box
1	Development Package CD	PLCDKCD-01	Loose Packed in Box
1	EZ Ladder CD	EZLDCD-01	Loose Packed in Box
1	Power Pack	PLCDKPS	Loose Packed in Box
1	PLC on a Chip DevKit Datasheet	2005002.X	Loose Packed in Box

Enabling the Battery

The PLC on a Chip Development Package includes a battery to support the real time clock. Prior to use the battery must be enabled. Pull the "Battery Saver" tag from the battery socket to enable the battery operation.

Other Support Information

Other documents are available for additional PLC on a Chip support.

-For Circuit Design, refer to the Divelbiss *PLC on a Chip Circuit Design Guidelines* document.

-For PLC on a Chip and PLC on a Chip Module EZ LADDER Configuration, refer to the Divelbiss *PLC on a Chip EZ LADDER Configuration* document

-For information of EZ LADDER installation and use, refer to the Divelbiss *EZ LADDER User's Manual*.

-For technical information regarding the PLC on a Chip, refer to the Divelbiss *PLC on a Chip Technical Data Sheet*.

-For technical information regarding the PLC on a Chip Module, refer to the Divelbiss *PLC on a Chip Module Technical Data Sheet*.

Main Board Diagram

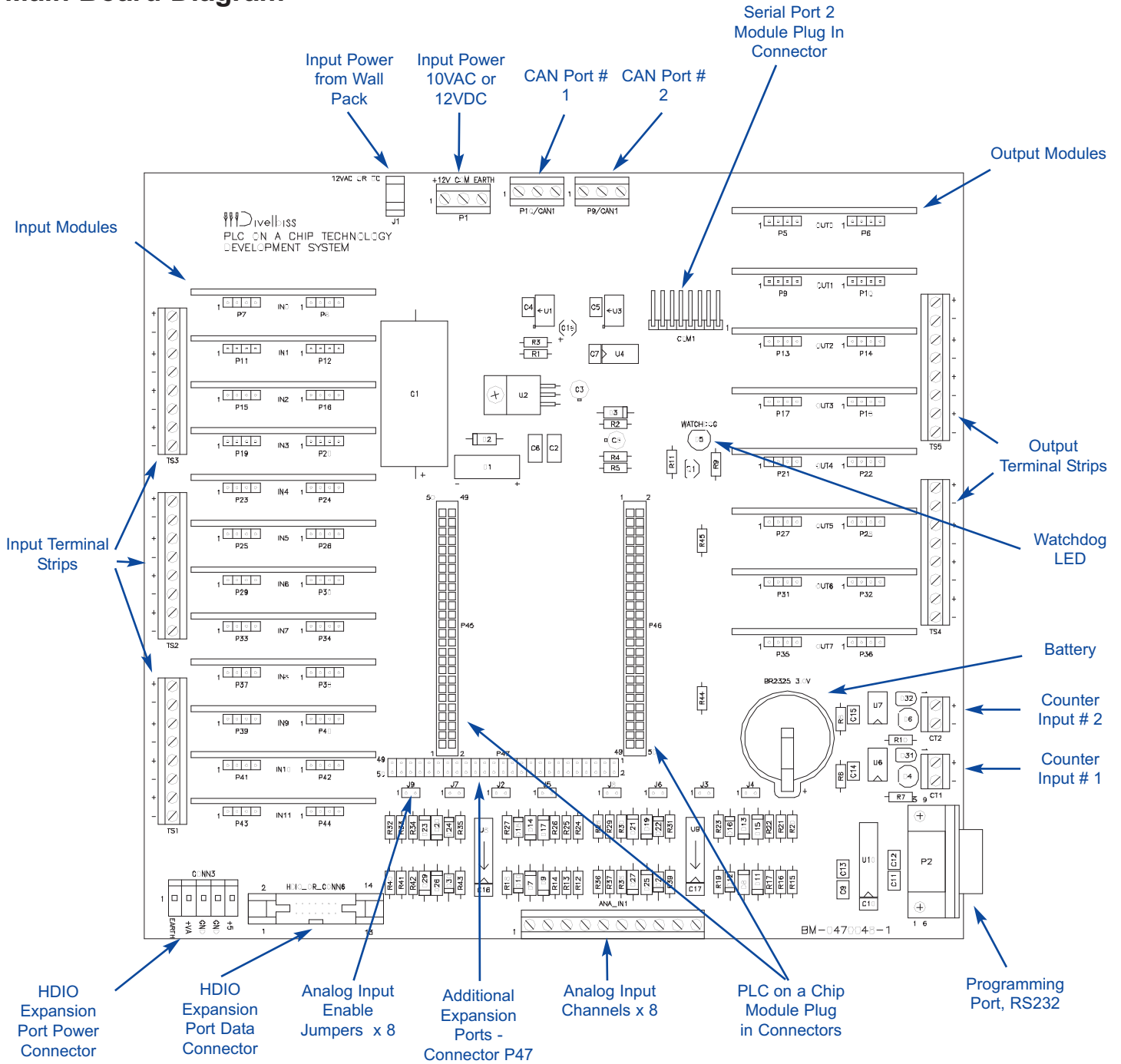

Main Board Features

Input Power

The PLC on a Chip Development Package main board is powered by using the provided plug in wall power pack (PLCDKPS). The wall power pack (PLCDKPS) connects to J1 on the main board (PLCDKMB). Additionally, P1 is provided to apply power from a different source. 10 VAC or +12 VDC may be connected to P1. J1 is not to be used when P1 is used.

P1 Power Connector Pin-out

- Pin 1 : + 12 VDC or 10 VAC
- Pin 2 : Common
- Pin 3 : Earth Ground

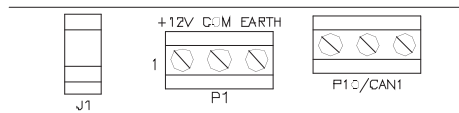

Serial Ports

Programming Port - COM 0

P2 (COM 0) is the programming port for the PLC on a Chip Development main board (PLCDKMB). This port should only be used for connecting to the EZ LADDER development platform software. A null modem cable and a PC serial port capable of 57.6K serial communication is required.

P2 Serial Port Connector Pin-out

- Pin 1 : NC
- Pin 2 : RX
- Pin 3 : TX
- Pin 4 : NC
- Pin 5 : GND
- Pin 6 : NC
- Pin 7 : RTS
- Pin 8 : CTS
- Pin 9 : NC

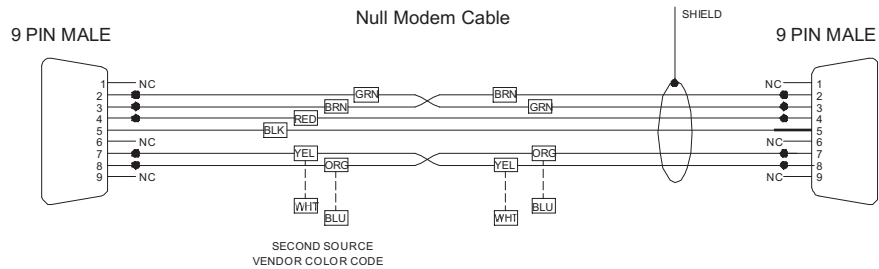

2nd Serial Port - COM 1

COM 1 is an expansion connector that accepts plug-in serial port modules. These modules may be purchased as RS232, RS422 or RS485. The plug-in modules plug into COM 1 as shown.

COM 1 Plug-in Modules

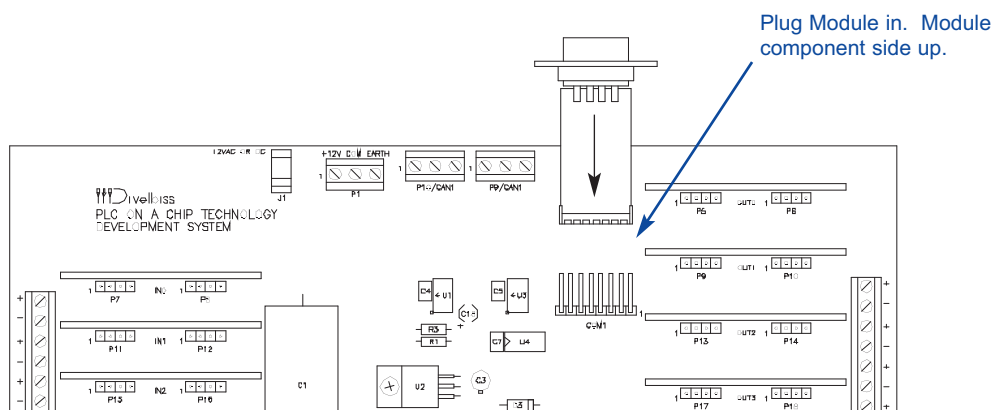

COM 1 is capable of baud rates to 115.2K. This port supports Modbus Slave (256K or higher Memory Models only).

RS232 Plug In Module Pin-out

- Pin 1 : NC
- Pin 2 : RX
- Pin 3 : TX
- Pin 4 : NC
- Pin 5 : GND
- Pin 6 : NC
- Pin 7 : RTS
- Pin 8 : CTS
- Pin 9 : NC

RS422 Plug In Module Pin-out

- Pin 1 : TX-
- Pin 2 : NC
- Pin 3 : NC
- Pin 4 : RX-
- Pin 5 : GND
- Pin 6 : RX+
- Pin 7 : NC
- Pin 8 : NC
- Pin 9 : TX+

RS485 Plug In Module Pin-out

- Pin 1 : TX-
- Pin 2 : NC
- Pin 3 : NC
- Pin 4 : NC
- Pin 5 : GND
- Pin 6 : NC
- Pin 7 : NC
- Pin 8 : NC
- Pin 9 : TX+

Analog Inputs

The PLC on a Chip main board (PLCDKMB) includes eight single ended analog input channels (10 bit) using connector ANA_IN1. These eight channels can accept signals of 0-5 VDC or 0-20m ADC. Each channel has an enable jumper (J2-J9). This jumper connects the channel's input circuitry to the PLC on a Chip analog input. A Channel should be disabled when using connector P47 to apply different signal conditioning for the analog input.

The analog input connector ANA_IN1 has the following pin-out.

- Pin 1 : GND
- Pin 2 : A/D Channel 0
- Pin 3 : A/D Channel 1
- Pin 4 : A/D Channel 2
- Pin 5 : A/D Channel 3
- Pin 6 : A/D Channel 4
- Pin 7 : A/D Channel 5
- Pin 8 : A/D Channel 6
- Pin 9 : A/D Channel 7
- Pin 10 : GND

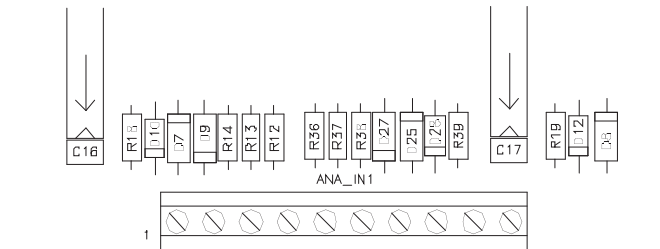

CAN Ports

The PLC on a Chip main board (PLCDKMB) includes 2 CAN port interfaces. These ports supports baud rates of up to 1Mbps. The CAN ports are connected as shown.

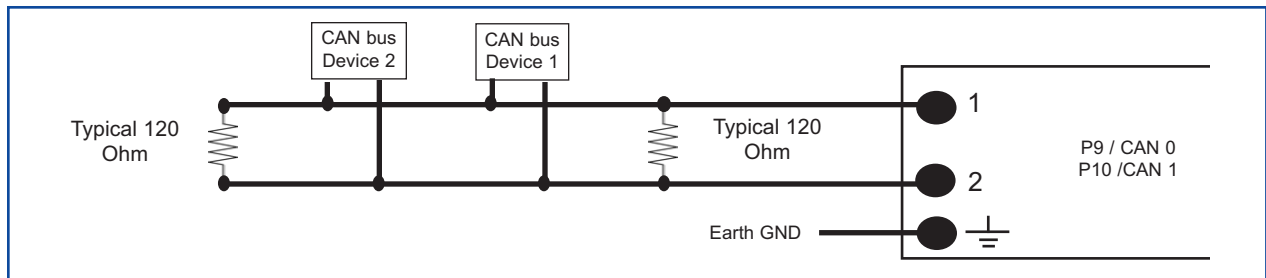

P9 / CAN 0 Pin-out

- Pin 1 : CAN H
- Pin 2 : CAN L
- Pin 3 : EARTH GND

P10 / CAN 1 Pin-out

- Pin 1 : CAN H
- Pin 2 : CAN L
- Pin 3 : EARTH GND

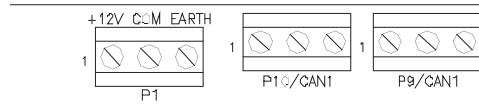

I/O Assignments

The PLC on a Chip main board (PLCDKMB) includes supports 12 inputs and 8 outputs on board. The I/O is addressed as shown.

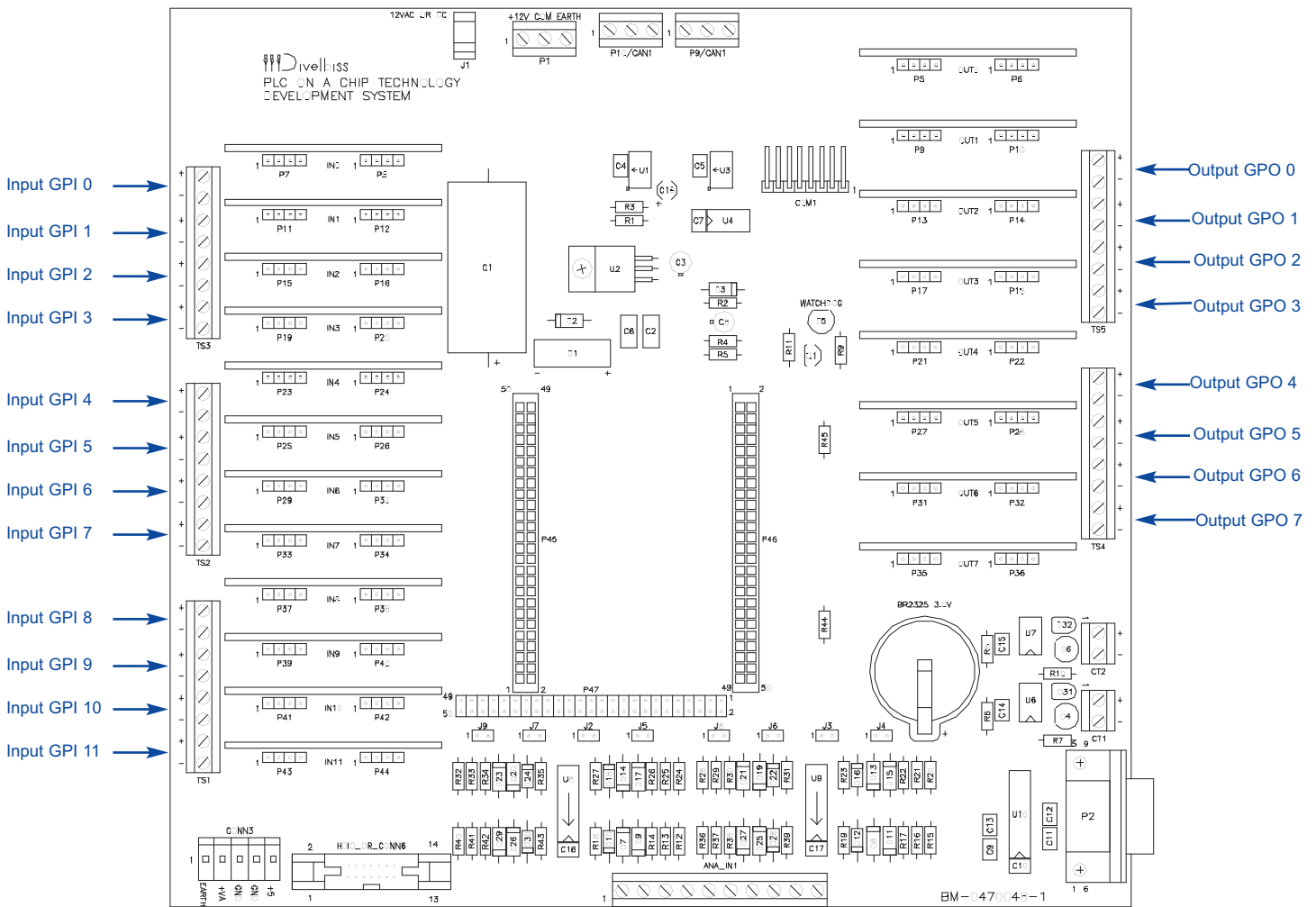

Installing & Removing I/O Modules

Each I/O point on the main board (PLCDKMB) is based on plug-in I/O modules. Any input module will operate in any of the main board input module positions. Any output module will operate in any of the main board output module positions.

To remove a module, make sure the power to the I/O and main board is off. Gently pull the module upward off of the board. It is held in place by two connections. There is an optional screw mount for each of the I/O modules which will need to be removed if installed prior to removing the module.

To install a module, make sure the power to the I/O and main board is off. Carefully align the module over its position. Gently plug the module to the main board being careful that both connections align and plug-in properly. There is an optional screw mount for each of the I/O modules. These holes will align when the module is installed properly.

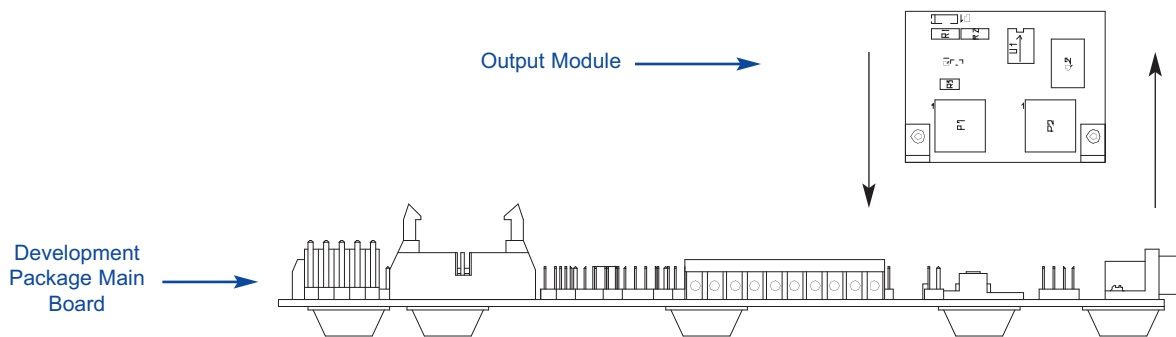

Installing & Removing PLC on a Chip Module

The PLC on a Chip Module is installed at the factory. Should the need arise, it may be removed and re-installed on the main board.

To remove the module, make sure the power to the I/O and main board is off. Grip the PLC on a Chip Module on opposite sides and gently rock the module back and forth while gently trying to pull the module. The module will loosen and become free from the main board after several rocking motions.

To insert the module, align the module over the connectors and gently press into place. Ensure the module is completely inserted.

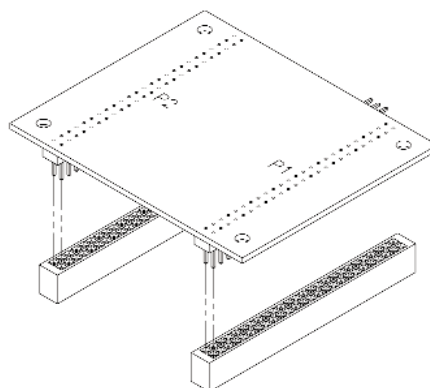

Connecting I/O

Each I/O point on the main board (PLCDKMB) is based on plug-in I/O modules. Any input module will operate in any of the main board input module positions. Any output module will operate in any of the main board output module positions.

INPUT MODULE CONNECTIONS

12-24VDC Input Module Connections

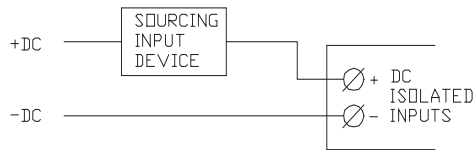

Sinking Input Circuit

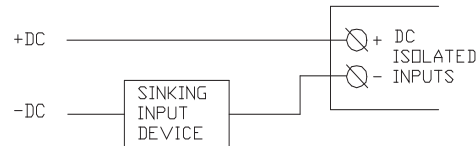

Sourcing Input Circuit

110VAC Input Module Connections

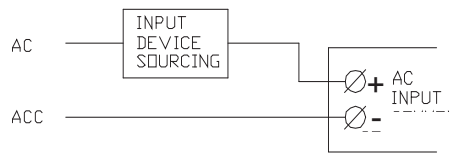

Sinking Input Circuit

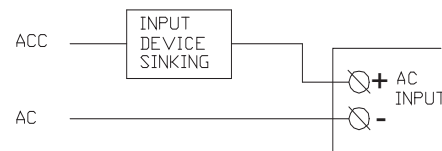

Sourcing Input Circuit

OUTPUT MODULE CONNECTIONS

12-24VDC Output Module Connections

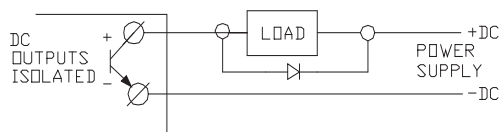

Sinking Output Circuit

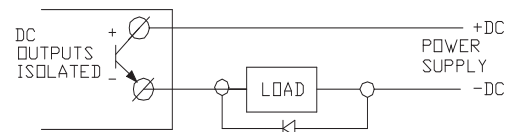

Sourcing Output Circuit

110VAC Output Module Connections

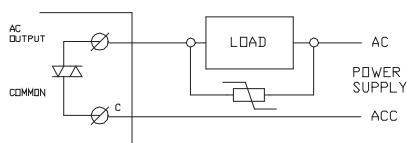

Sinking Output Circuit

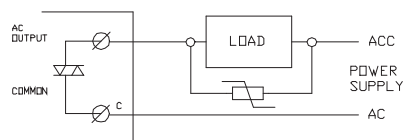

Sourcing Output Circuit

Relay Output Module Connections

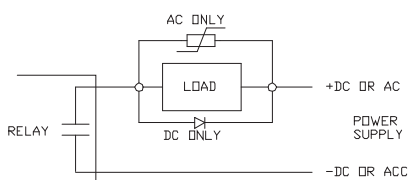

Sinking Output Circuit

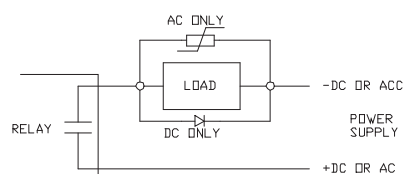

Sourcing Output Circuit

Counter Inputs

The main board provides two on-board counter inputs. These up counter inputs are capable of rates to 500 KHz. Connect the CT1 and CT2 inputs as shown. The counter is optically isolated to provide immunity from noise and interference.

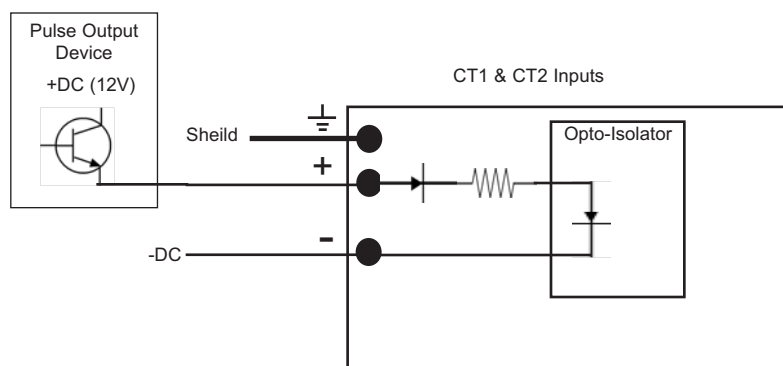

High Density I/O Interface

For addition I/O requirements. Connector 3 and Connector 6 are provided to interface directly to Divelbiss High Density I/O expansion boards (ICM-HDIO-XX). HDIO expansion boards are available in a variety of types and voltage levels. Simply address the HDIO board and connect it to the development main board using CONN 3 and CONN 6.

The I/O addressing for the ICM-HDIO-XX are as follows:

Digital Inputs: DI0.0 - DI7.15

Digital Outputs: DO0.0 - DO7.15

Real Time Clock

The PLC on a Chip Module includes a Real Time Clock. The real time clock (after set) provides Month, Day, Day of the Week, Year, Hour, Minute and Second. The real time clock maintains time when power is lost via lithium battery.

The life of the battery for the real time clock generally has years of life before replacement is needed. Should the battery need to be replaced, replace the battery with the same type and size as the original. The battery is a Lithium Coin Cell, Type BR2325.

Additional Expansion Ports - P47

The main board includes an additional expansion connector - P47. This connector allows access to additional PLC on a Chip pins as well as some of the circuitry on the main board.

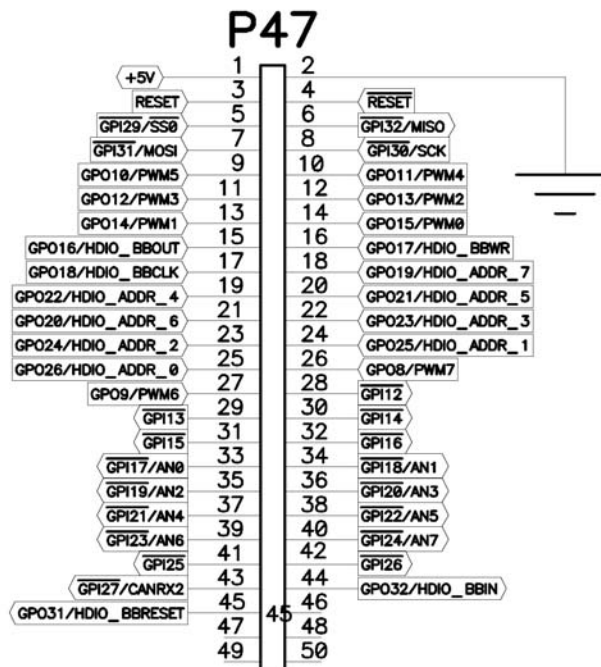

Important Product Notice

Use of products supplied herewith by Divelbiss Corporation ("Divelbiss") is strictly subject to the following conditions.

Divelbiss reserves the right to make corrections, modifications, enhancements, discontinuation, and other changes without further notice to any products supplied herewith to improve reliability, function or design. Divelbiss assumes no responsibility or liability for the use of any of these products, conveys no license or title under any patent, copyright, mask work right, or other Divelbiss intellectual property right relating to any combination, machine, or process in which Divelbiss products are used. Divelbiss makes no representations or warranties that these products are free from patent, copyright, or mask work right infringement, unless otherwise specified.

Divelbiss assumes no liability for applications assistance or customer product design. Customers are responsible for their products and applications using Divelbiss components. To minimize the risks associated with customer products and applications, customers should provide adequate design and operating safeguards.

Divelbiss products are not designed, intended, or authorized for use as components in systems intended for surgical implant into the body, or other applications intended to support or sustain life, related to the operation of nuclear facilities, in environments otherwise intended to be fault-tolerant or for any other application in which the failure of the Divelbiss product could create a situation where personal injury or death may occur. Should a customer purchase or use Divelbiss products for any such unintended or unauthorized application, such customer shall indemnify and hold Divelbiss and its officers, employees, subsidiaries, affiliates, and distributors harmless against all claims, costs, damages, and expenses, and reasonable attorney fees arising out of, directly or indirectly, any claim of personal injury or death associated with such unintended or unauthorized use, even if such claim alleges that Divelbiss was negligent regarding the design or manufacture of the part.

Device parameters which may be provided in Divelbiss datasheets and/or specifications can and do vary in different applications and actual performance may vary over time. All operating parameters must be validated for each customer application by customer's technical experts. Customers should obtain the latest relevant information before placing orders and should verify that such information is current and complete.

DIVELBISS MAKES NO WARRANTY, REPRESENTATION OR GUARANTEE REGARDING THE SUITABILITY OF THE PRODUCTS SOLD HEREWITH FOR ANY PARTICULAR PURPOSE, NOR DOES DIVELBISS ASSUME ANY LIABILITY ARISING OUT OF THE APPLICATION OR USE OF ANY PRODUCT OR CIRCUIT, AND SPECIFICALLY DISCLAIMS ANY AND ALL LIABILITY, INCLUDING WITHOUT LIMITATION LOSS OF PROFITS, LOSS OF BUSINESS OR GOODWILL, LOSS OF DATA OR USE OF DATA, INTERRUPTION OF BUSINESS, AND FOR ANY INDIRECT, SPECIAL, CONSEQUENTIAL OR INCIDENTAL DAMAGES OF ANY KIND, HOWEVER CAUSED, WHETHER ANY SUCH CLAIM SOUNDS IN CONTRACT, TORT, STRICT LIABILITY OR OTHER LEGAL OR EQUITABLE THEORY, EVEN IF DIVELBISS HAS BEEN ADVISED OF THE POSSIBILITY OF SUCH LOSS. THE DIVELBISS PRODUCT SOLD HEREWITH IS SUPPLIED "AS IS." CUSTOMER IS RESPONSIBLE TO INSURE THAT THE DIVELBISS PRODUCT SOLD HEREWITH IS IMPLEMENTED PROPERLY IN AN APPROPRIATE APPLICATION.

Any use or configuration of the PLC ON A CHIP Kernel software is strictly subject to the terms of the Divelbiss EZ LADDER OEM Software License Agreement (a copy of which may be obtained upon request from Divelbiss), and may be undertaken only in connection with designated products.

PLC ON A CHIP Kernel software may not be amended, modified, decompiled, reverse engineered, copied, or installed on a network, nor may any rights therein be sublicensed, conveyed or purportedly conveyed without the express, written consent of Divelbiss.