

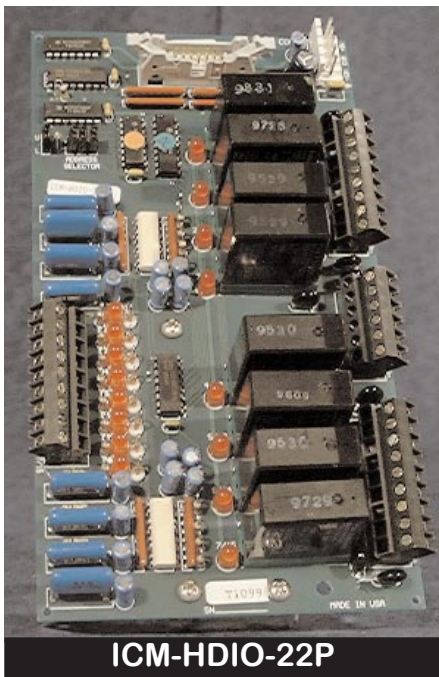

Electronic Solutions for the 21st Century

ICM-HDIO-22P

High Density I/O Expander - 8 In AC Commoned 8 Out Dry Relay Contacts Form C



ICM-HDIO-22P

PRODUCT DESCRIPTION:

The ICM-HDIO-22P is designed for direct connection with any of the Divebiss *Bear Bones*, *High Density Bear Bones*, *Boss Bear*, *Boss32*, *Universal Control Panel (UCP)* and *Universal Machine Controller (UMC)* product families.

PRODUCT FEATURES:

- Quickly Connects using ICM-HDCA Series Cables
- Optically Isolated I/O points
- Reverse polarity protection
- Small size and light weight
- Mounts on industry standard DIN rail type NS31 or NS35
- Addressable via programming jumpers
- Detachable Input / Output blocks
- Polarized and locking data and power bus connections
- LED monitoring of I/O status
- Engineered to meet NEMA part ICS 3-304
- AC Commoned Inputs & Dry Relay Form C Outputs

Data Sheet



Table of Contents

Input Specifications.....	2
Typical Input Connections & Circuit Diagrams.....	2
Output Specifications.....	3
Typical Output Connections & Circuit Diagrams.....	3
Addressing I/O Points.....	4
Power Consumption.....	4
Data Connections.....	4
Mounting & Dimensions.....	4
Connectivity Diagrams.....	5
Cabling.....	5

----WARNING----

The ICM-HDIO-22P, as with other solid state control devices, must not be used in applications which would be hazardous to personnel in the event of failure of the controller. Precautions must be taken to provide mechanical and/or electrical safeguards external to the controller. This device is **NOT APPROVED** for domestic or human medical use.



INPUT SPECIFICATIONS:

# Channels:	8
Input Voltage:	115 VAC Nominal, Sinusoidal
Turn on Level:	85VAC @ 10.6mAAC Minimum
Turn off Level:	45VAC @ 5.6mAAC Maximum
Turn on Time:	50mSec Nominal @ 120VAC, 60 Hz
Turn off Time:	50mSec Nominal @ 120 VAC, 60 Hz
Isolation (Input to Logic Level):	3KV Minimum for 1 Second
Isolation (Interchannel):	3KV Minimum for 1 Second
Static Input Resistance:	8KOhm Nominal @ 60 Hz
Input Types:	Sink or Source
Optical Isolation:	Yes
LED Status Indicators:	Yes

TYPICAL INPUT CIRCUIT DIAGRAMS

Typical ICM-HDIO-22P Input Circuit

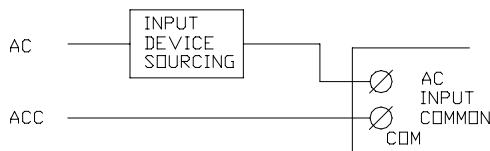
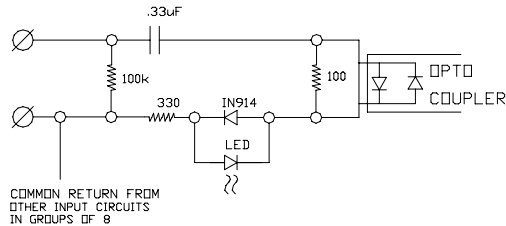

Sinking Input Circuit

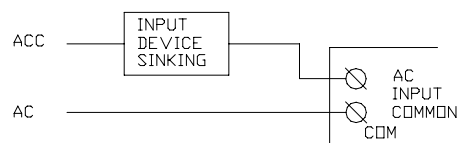

Sourcing Input Circuit



OUTPUT SPECIFICATIONS:

# Channels:	8
Installed Relays:	0 (ICM-RE-03)
Operate Time:	15 mSec (Approximately)
Release Time:	8 mSec(Approximately)
Switching Currents:	
DC:	10 Amps @ 30 VDC
AC:	10 Amps (1/4 HP) @ 125/250 VAC *
Initial Breakdown Voltages:	
Between Contacts:	1000Vrms
Coil to Contacts:	4000Vrms
Expected Life Mechanical:	5x10 ⁷ Minimum (at 180 cpm)
Expected Life Electrical:	100,000 Operations
Output Types:	Sink or Source
Optical Isolation:	Yes
LED Status Indicators:	Yes

* MOV Removed at 250 VAC
Note: No Relays pre-installed. Must be ordered using ICM-RE-03

TYPICAL OUTPUT CIRCUIT DIAGRAMS

Typical ICM-HDIO-22P Output Circuit

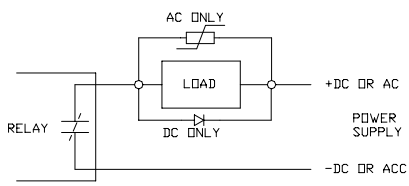
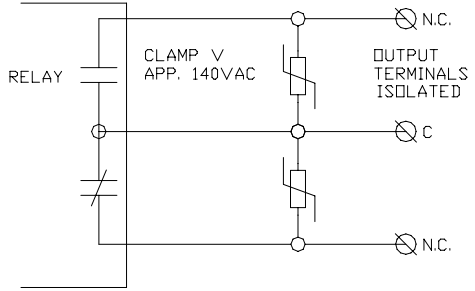

Typical Output Circuit



Addressing I/O Points

The I/O is addressed into “pages”. Each “page” represents 16 inputs and 16 outputs. The HDIO-22P addresses a “half page”. It may be addressed to any page 0 through 7. Limitations apply when connected to a *Bear Bones*, *Baby Bear Bones* or *High Density Bear Bones* CPU. When connected to these CPUs, the HDIO may **NOT** be addressed on “Page 1”. “Page” selection is done via programming shunts “Address Selector(s) 1,2,4,8”. See page selection to the right for more details. **Note: Some models may only use selectors 1,2,4. Page 6 cannot be address when HDIO is used with PIC-AB-01.*

Card Page Address	Card Paging Shunts (Address Selector) 8 4 2 1	U/L Selector		DIN/ DOUT 8 I/O Cards	DIN/ DOUT 16 I/O Cards	Card Page Address	Card Paging Shunts (Address Selector) 8 4 2 1	U/L Selector		DIN/ DOUT 8 I/O Cards	DIN/ DOUT 16 I/O Cards
		Lower	Upper					Lower	Upper		
0	■ ■ ■ ■	U	L	0-7 8-15	0-15	8	○ ○ ■ ■	U	L	128-135 136-143	128-143
1	■ ■ ■ ■	U	L	16-23 24-31	16-31	9	○ ○ ■ ■	U	L	144-151 152-159	144-159
2	■ ■ ■ ■	U	L	32-39 40-47	32-47	10	○ ○ ■ ■	U	L	160-167 168-175	160-175
3	■ ■ ■ ■	U	L	48-55 56-63	48-63	11	○ ○ ■ ■	U	L	176-183 184-191	176-191
4	■ ■ ■ ■	U	L	64-71 72-79	64-79	12	○ ○ ■ ■	U	L	192-199 200-207	192-207
5	■ ■ ■ ■	U	L	80-87 88-95	80-95	13	○ ○ ■ ■	U	L	208-215 216-223	208-223
6	■ ■ ■ ■	U	L	96-103 104-111	96-111	14	○ ○ ■ ■	U	L	224-231 232-239	224-239
7	■ ■ ■ ■	U	L	112-119 120-127	112-127	15	○ ○ ■ ■	U	L	240-247 248-255	240-255

Power Consumption

Power Input Standby:	+5VDC @ 2mA Maximum
Power Input Origin:	Controller/Aux Powersupply via Cable 3
I/O Point Power Consumption:	
Activated Inputs:	1.7mA each input point (5V Supply) (additional)
Activated Outputs:	.5mA each output point (5V Supply) (additional) 44mA each output point (12V Supply)(additional)

DATA CONNECTIONS

The data is received from the controller via a ribbon cable connected to Conn6. The controller provides all the addressing, data and selection signals necessary for complete operation.

MOUNTING & DIMENSIONS

Mounting Type:	Industry Standard DIN Rail NS 31 or NS 35
Dimensions:	
Width:	4.25 Inches
Length:	7.9 Inches
Depth:	2.4 Inches (including din rail mounting feet)



CONNECTIVITY DIAGRAMS

For additional Addressing, See Chart on Page 4.

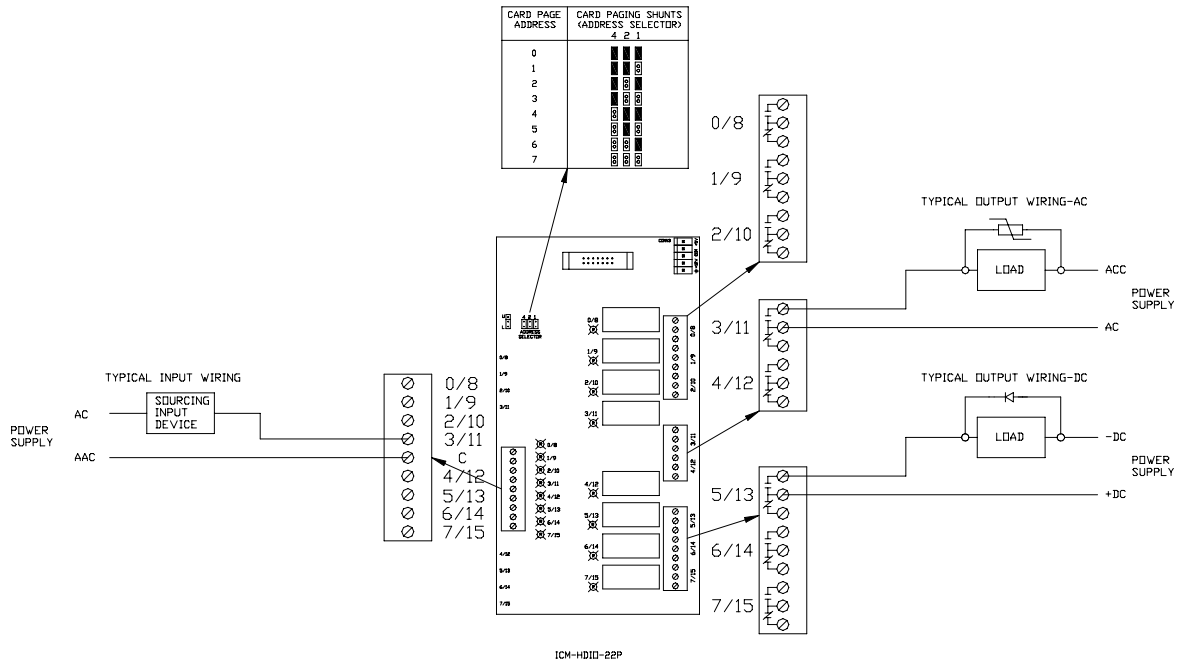

Maximum Recommended wire size is 14 AWG.

CABLING

The ICM-HDIO-22P connects to any of the Divebiss controllers using standard cable sets. See below for proper cable. Custom Cabling is also available.

Connect to Boss32, UCP, UMC and HDCPU.

ICM-HDCA-01	Connects 1 Expander (9")
ICM-HDCA-02	Connects 2 Expander (18")
ICM-HDCA-03	Connects 3 Expander (27")
ICM-HDCA-04	Connects 4 Expander (36")
ICM-HDCA-05	Connects 5 Expander (45")
ICM-HDCA-06	Connects 6 Expander (54")

Connect to Boss Bear, Bear Bones, and Baby Bear Bones.

ICM-HDCA-11	Connects 1 Expander (9")
ICM-HDCA-12	Connects 2 Expander (18")
ICM-HDCA-13	Connects 3 Expander (27")
ICM-HDCA-14	Connects 4 Expander (36")
ICM-HDCA-15	Connects 5 Expander (45")
ICM-HDCA-16	Connects 6 Expander (54")

Data Sheet